

Article number: 203180M1675C3T

Description: E+G levelling foot

GN 31-80-M16-75-C3-T

Note: T Without nut, Wrench flat at the bottom

Measures

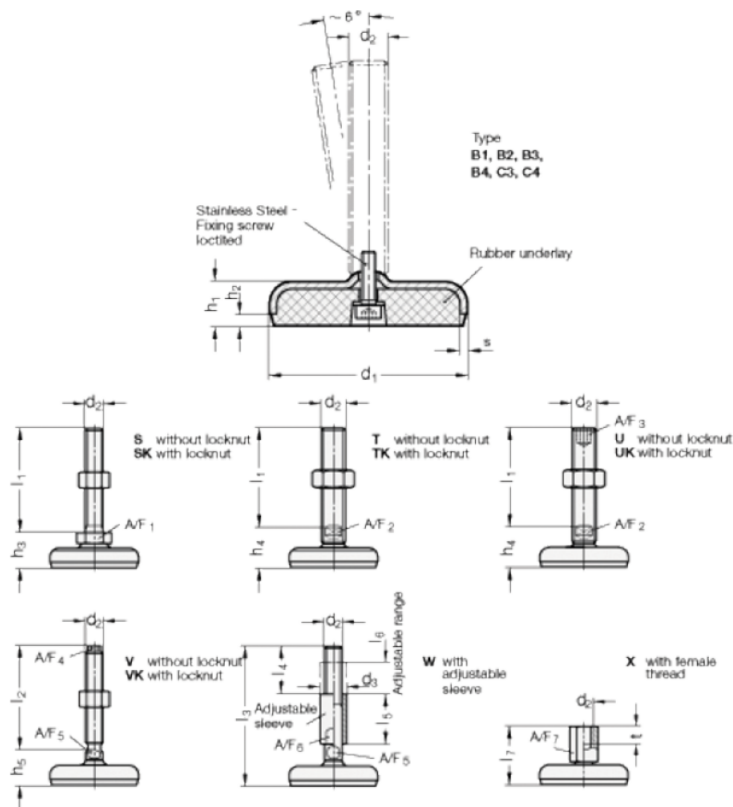

A/F2	= 12
d1	= 80
d2	= 16
h1	= 18
h2	= 5
h4 +4.0/0	= 32
l2	= 75
s	= 3